

ATLANTA

STRETCH

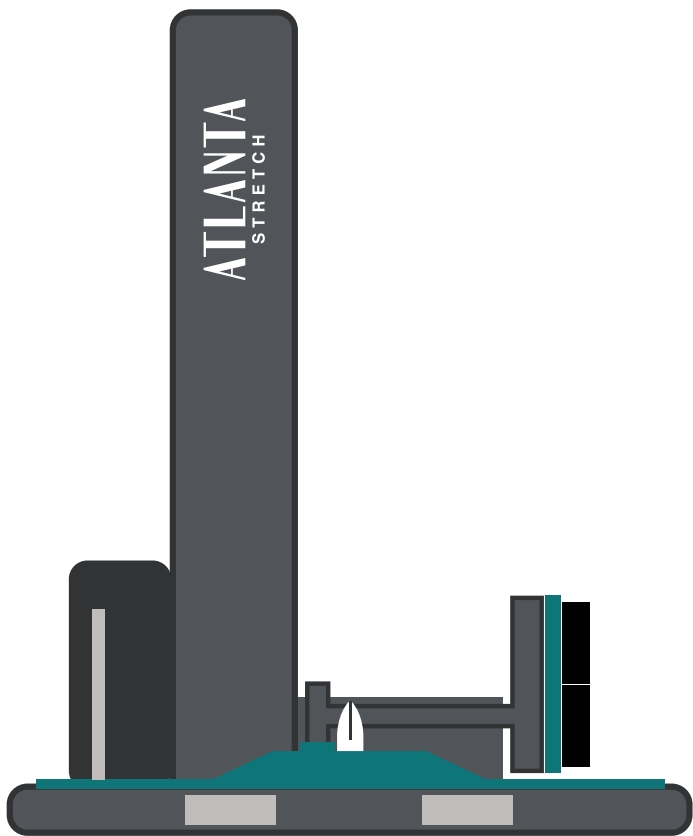

MYTHO AUTO

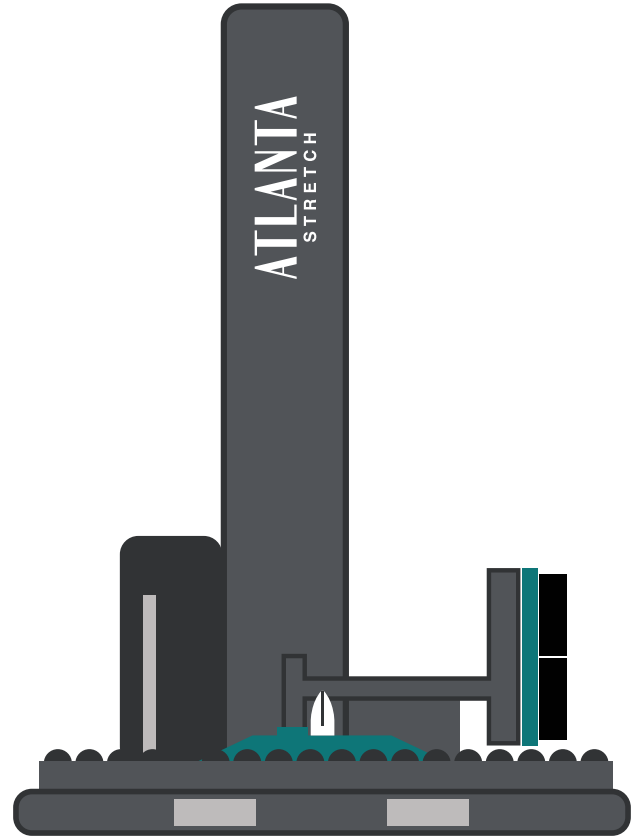

MYTHO STATION

PALLET WRAPPING MACHINE
MAINTENANCE FREE
EASY INSTALLATION

**Turntable for wrapping pallets
with stretch film without operator**

MYTHO AUTO

Input: 230 Volt
1 PHASE



SPOOL FILM CARRIAGE

CONTROL PANEL

TURNTABLE

ATLANTA STRETCH UNIQUE SOLUTION

- IT** Protezioni di sicurezza non necessarie per CE – IIA totale
- EN** Safety Fences not necessary for Full CE - IIA
- FR** Les clôtures de sécurité ne sont pas nécessaires pour le plein CE – IIA
- DE** Sicherheitszäune nicht erforderlich für volles CE - IIA
- ES** Las vallas de seguridad no son necesarias para CE - IIA completo

MYTHO AUTO TP

Input: 230 Volt
1 PHASE

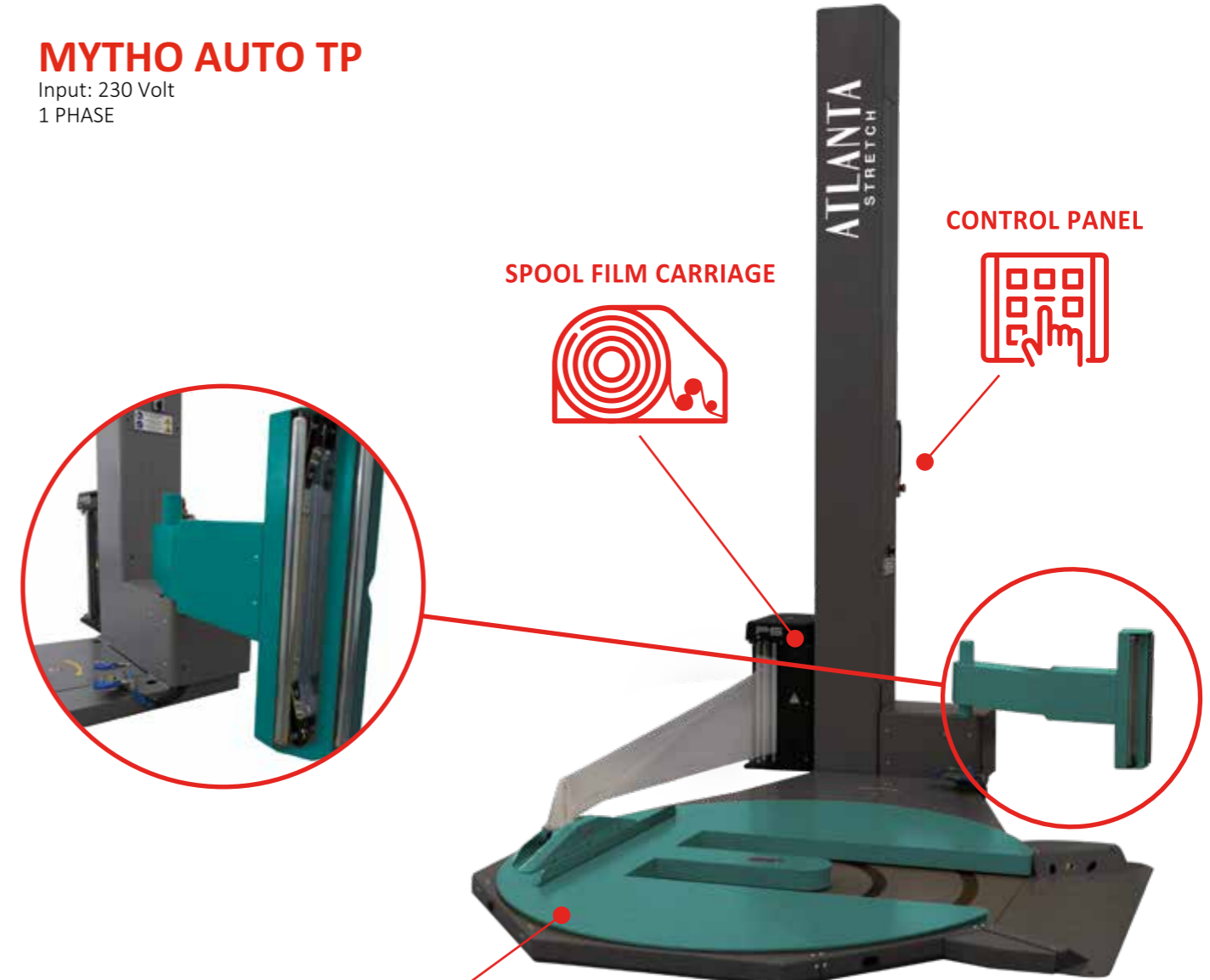

SPOOL FILM CARRIAGE

CONTROL PANEL

TURNTABLE

CLAMP AND CUTTING SYSTEM

- IT** Sistema saldatura del film estensibile autoregolante per qualsiasi dimensione del pallet.
- EN** Film weld unit self adjusting for any size of pallet.
- FR** Système de soudure du film étirable à réglage automatique pour toutes dimensions de la palette.
- DE** Selbsteinstellendes Folienende Verschweißsystem passt sich auf sämtliche Palettengrößen automatisch an.
- ES** Sistema soldadura del film extensible autorregulable para cualquier dimensión de palet.

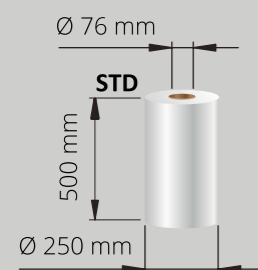

PALLET DIMENSIONS

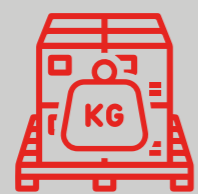

Max: 2000 Kg STD

Mytho Mast

- H = 2200 STD
- H = 2400 OPT
- H = 2500 OPT
- H = 3000 OPT
- H = 3200 OPT
- H = 3500 OPT
- H = 3900 OPT

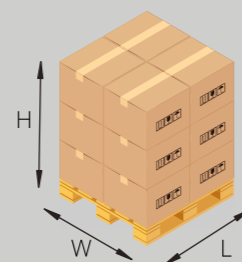

WxL mm	MAX Ø mm
800x1200	1500 STD
1000x1200	1650 OPT
1200x1200	1800 OPT
1500x1500	2200 OPT
1650x1650	2400 OPT
1830x1830	2600 OPT

APPLICATIONS

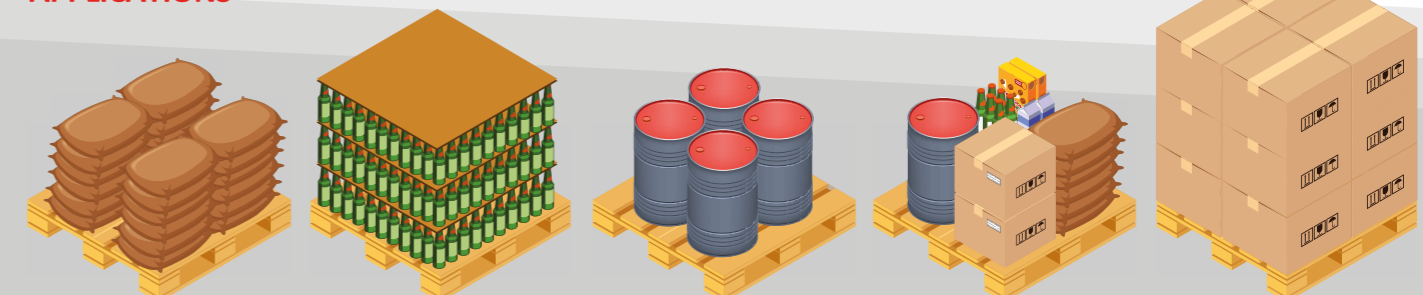



ATLANTA STRETCH SELLING POINTS

EXCHANGEABLE CARRIAGES



- IT** Carrelli porta bobina intercambiabili anche dopo la consegna della macchina con un notevole risparmio.
- EN** The carriage can be upgraded even after delivery, to achieve lower costs of ownership.
- FR** Le chariot peut être mis à niveau même après la livraison, afin de réduire les coûts de possession.
- DE** Austauschbarer Folienschlitten auch nach Auslieferung der Maschine, zur Reduzierung der Betriebskosten
- ES** El carro se puede actualizar incluso después de la entrega, para lograr menores costos de propiedad.

ERGONOMIC SOLUTION FOR THE USER



- IT** L'attenzione alla sicurezza e al massimo comfort del lavoratore contribuiscono a migliorare la qualità del lavoro, diminuendo lo stress a favore della soddisfazione generale dell'utente
- EN** For the highest security and safety of the user and to achieve a better working environment, and higher satisfaction of the user.
- FR** Pour la plus grande sécurité et sûreté de l'utilisateur et pour obtenir un meilleur environnement de travail et une plus grande satisfaction de l'utilisateur.
- DE** Für höchste Sicherheit des Nutzers, sowie zur Erreichung eines besseren Arbeitsumfelds und Zufriedenheit
- ES** Para la mayor seguridad y protección del usuario y para lograr un mejor ambiente de trabajo, y una mayor satisfacción del usuario.

COMMERCIAL COMPONENTS AND INVERTERS AVAILABLE ON THE FREE MARKET



- IT** La facilità con cui i nostri componenti sono reperibili sul mercato contribuisce ad abbatterne il prezzo con notevole risparmio per l'utente.
- EN** The use of commercial components in all our products means higher reliability and lower costs but also flexibility in terms of materials supply.
- FR** La façon dont nous nous approvisionnons et spécifions des niveaux élevés pour les composants de nos produits, signifie que vous bénéficierez de niveaux de fiabilité élevés et constants
- DE** Der Einsatz handelsüblicher Komponenten in all unseren Produkten bedeutet höhere Zuverlässigkeit und geringere Kosten, aber auch Flexibilität bei der Materialversorgung.
- ES** El uso de componentes comerciales en todos nuestros productos significa mayor confiabilidad y menores costos, pero también flexibilidad en términos de suministro de materiales.

POSSIBILITY TO ADJUST TENSION ON LOAD AND PRE STRETCH IN EVERY STEP OF THE WRAPPING CYCLE



- IT** I nostri carrelli offrono la possibilità di regolare in maniera mirata la tensione del film e il pre-stretch in ogni fase dell'avvolgimento.
- EN** Our carriages are standard equipped with the possibility to adjust film tension and pre-stretch during every phase of the wrapping process.
- FR** Nos chariots sont tous équipés en mode standard avec la possibilité de régler la tension du film et de le pré-étirer à chaque étape du processus d'emballage.
- DE** Unsere Folienschlitten sind so konzipiert, dass sowohl die Anlegespannung als auch die Folienvordehnung in jeder Phase des Wickelzyklus regulierbar sind.
- ES** Nuestros carros están equipados de serie con la posibilidad de ajustar la tensión de la película y preestirar durante cada fase del proceso de envoltura.



OPERATING PANEL

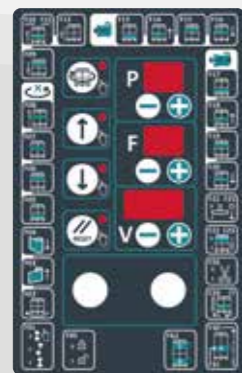

DISPLAY 11" easy to use touch screen

Mytho Auto: 99 PROGRAMS

- IT** Pannello di controllo multifunzionale programmabile
- EN** Multifunction programmable control panel
- FR** Panneau de controle multifonction programmable
- DE** Multifunktion programmierbare Systemsteuerung
- ES** Panel de control programable multifuncion

MYTHO STATION

Input: 230 Volt
1 PHASE



SPOOL FILM CARRIAGE

CONTROL PANEL



TURNTABLE

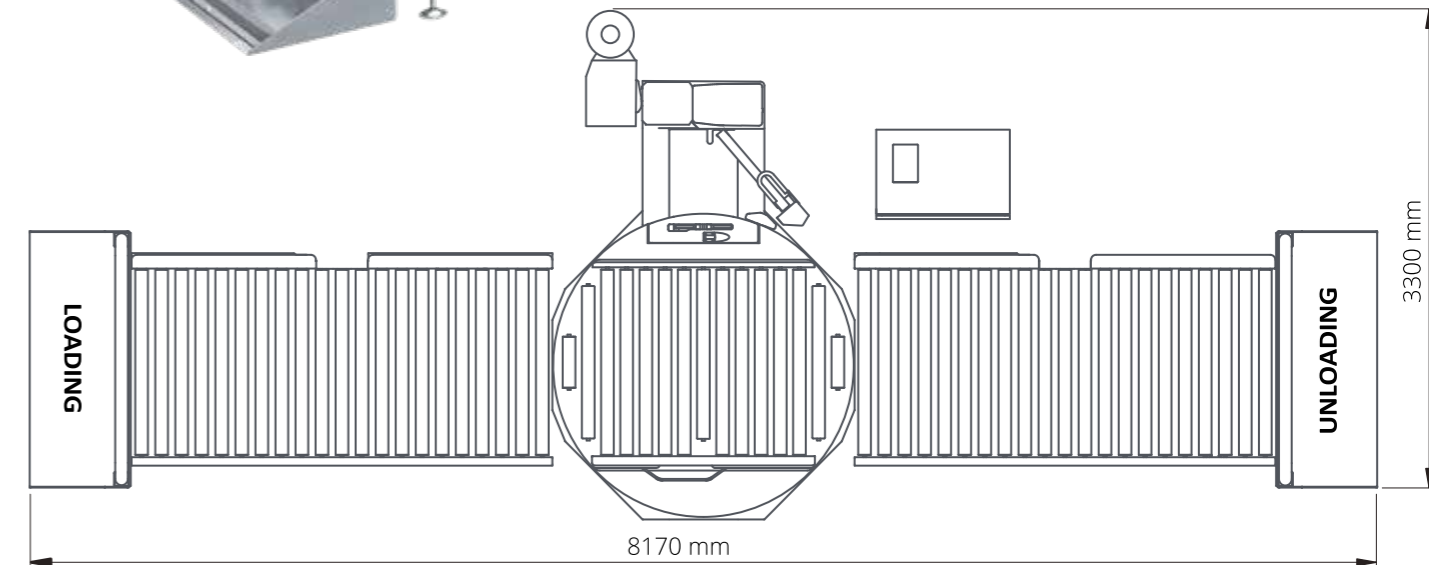
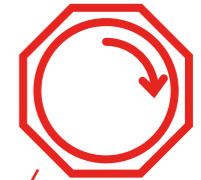

WRAPPING PROGRAMS

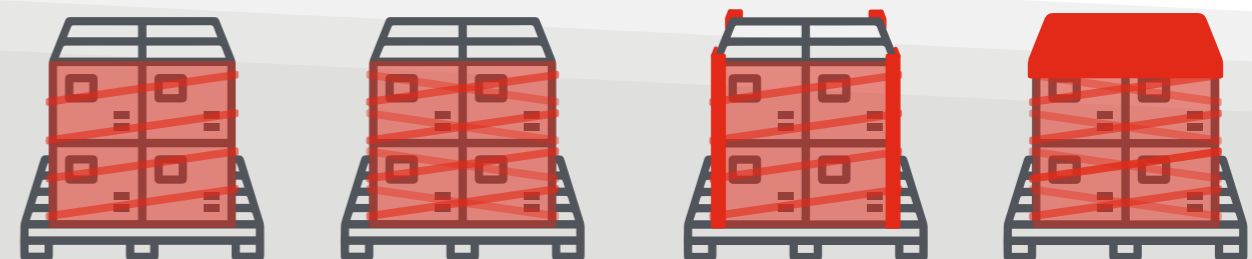

SPOOL FILM CARRIAGE



EASY FILM CHANGE

- IT** Cambio film semplificato, altezza di arresto del carrello porta bobina automatico.
- EN** Easy reel change, adjustable service height.
- FR** Changement de bobine facile, hauteur de service réglable.
- DE** Einfacher Folienwechsel in ergonomischer Arbeitshöhe.
- ES** Cambio fácil de bobina, altura de embalaje ajustable.

FE

- IT** Frizione elettromagnetica regolabile da pannello comandi.
- EN** Electromagnetic friction adjustable from control panel.
- FR** Frein électromagnétique réglable depuis le panneau de commande.
- DE** Elektromagnetische Bremse auf Umlenkwalze vom Bedienpult instellbar.
- ES** Fricción electromagnética regulable desde el panel de comandos.

PRS POWER ROLLER STRETCH

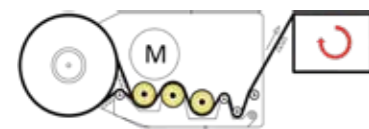

- IT** Sistema di prestiro motorizzato a 3 rulli comandato elettronicamente con rapporti intercambiabili: 150- 200- 250%.
- EN** Motorized pre-stretch system with 3 driven rollers electronically controlled with interchangeable ratios: 150- 200- 250%.
- FR** Système de pré-étirage motorisé et asservi à 3 rouleaux, rapports interchangeables: 150- 200- 250%.
- DE** Angetriebener Vordehnssystem mit 3 Vordehnrollen, elektronisch gesteuert mit leicht wechselbarer Zahnradsätzen: 150- 200- 250%.
- ES** Sistema de prestiro motorizado con 3 rodillos, comandado electrónicamente con desarrollos intercambiables: 150- 200- 250%.

PS POWER STRETCH

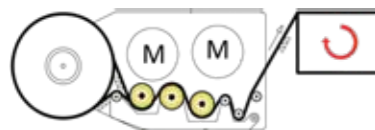

- IT** Sistema di motorizzato a 3 rulli con 2 motori e variazione da 120 a 350% regolabile da quadro comandi.
- EN** Motorized pre-stretch system with 3 driven rollers and 2 motors adjustable between 120 to 350% from control panel.
- FR** Système de pré-étirage motorisé et asservi à 3 rouleaux et 2 moteurs, rapport ajustable de 120 à 350% depuis le panneau de commande.
- DE** Angetriebener Vordehnssystem mit 3 Vordehnrollen und 2 Motoren, stufenlos regelbare Werte zwischen 120 und 350% von Bedienpult.
- ES** Sistema de prestiro motorizado con 3 rodillos y 2 motores, regulable da 120 a 350% desde el panel de comandos.

MEANS OF LOADING MYTHO AUTO

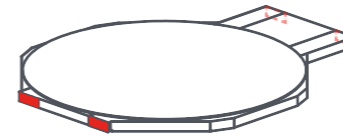

FORK SLOTS ON BOTH SIDES FOR EASY TRANSPORT



- IT** Trasporto facile
- EN** Easy transport
- FR** Transport facile
- DE** Einfachen transport
- ES** Facil transporte

TP BASEMENT



- IT** Versione transpallet con 3 possibili vie di carico. Direzione di ingresso tp modificabile anche dopo consegna.
- EN** Transpallet version with 3 in-feeds. Infeed direction changeable lifetime.
- FR** Ausführung Transpallet mit 3 adenmöglichkeiten.
- DE** Version transpalette 3 voies.
- ES** Version transpallet 3 posiciones de carga.

Pallet dimension
 Ø 1650 Max 1000x1200 mm
 Ø 1800 Max 1200x1200 mm
 Max weight 1200 kg

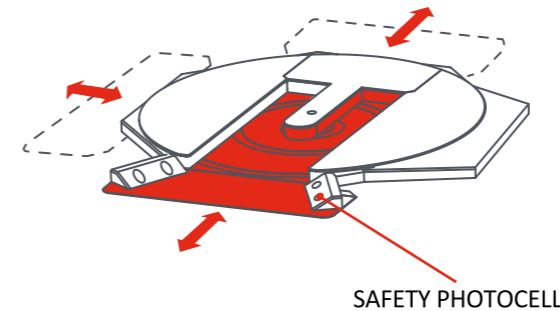

SAFETY PHOTOCCELL

OPTIONALS

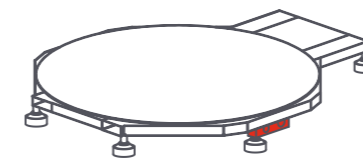

INTEGRATED WEIGHTING SYSTEM (ALSO FOR TP TURNTABLE)

- IT** Sistema elettronico per l'indicazione del peso del estensibile utilizzato.
- EN** Integrated calculation system, to indicate the weight of the used stretchfilm.
- FR** Système de calcul intégré pour indiquer le poids de film utilisé.
- DE** Integriertes Berechnungssystem, um das Gewicht des verwendeten Stretchfilms anzuzeigen.
- ES** Sistema integrado de cálculo, que indica el peso del plástico de preestiro utilizado.

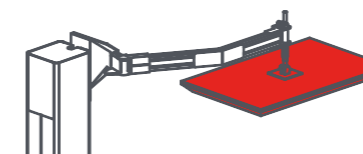

TOP PRESSURE UNIT

- IT** Pressore tenuta pallet
- EN** Pallet holder presser
- FR** Plateu stabilisateur de charge
- DE** Palettendruchalter
- ES** Prensor retencion palet

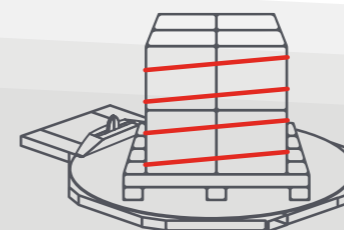

ROPING SYSTEM

- IT** Sistema di cordonatura film: Permette di ridurre l'altezza del film formando un cordone che assicura una più efficiente stabilizzazione del carico.
- EN** Roping System: Reducing the film width to form a rope to ensure more effective load stabilisation.
- FR** Systeme permettant de réduire la laize du film en formant un cordon qui assure une meilleure stabilisation de la charge.
- DE** Schnurrvorrichtung: Reduzierung der Folienbreite zur Schnur um eine bessere Stabilisierung der Ladung zu gewährleisten.
- ES** Sistema de Cordón. Permite reducir la altura del film formando un cordón que asegura con mas eficacia la estabilidad de la carga.

SEMI AUTOMATIC RANGE

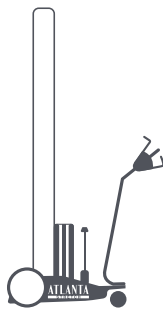

MARATHON

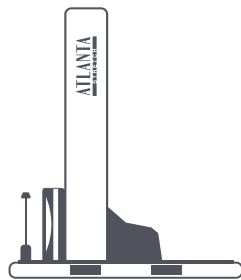

EVA

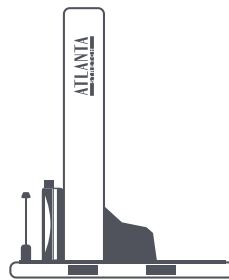

SYNTHESI

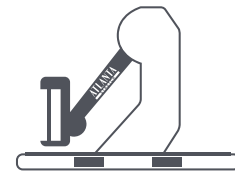

MYTHO ARM

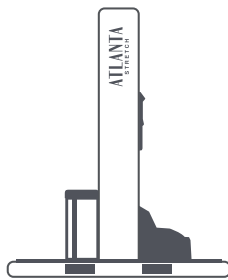

MYTHO S



SFERA

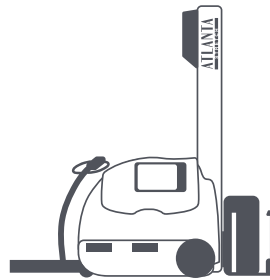

SFERA MAST



NEOS

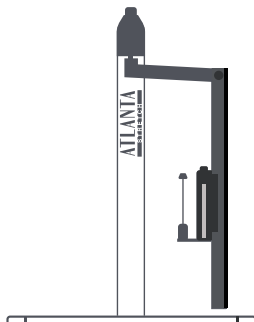

LYBRA EASY

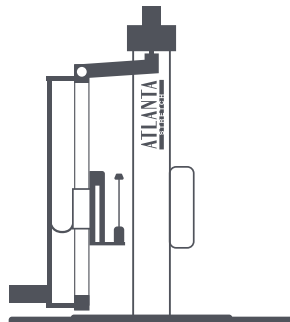

LYBRA

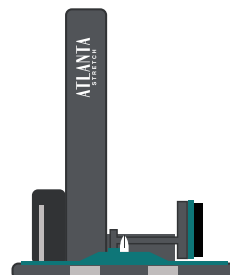

MYTHO AUTO

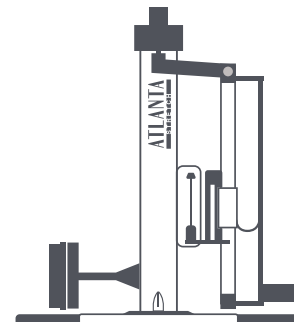

LYBRA AUTO

Atlanta Stretch Authorized dealer

ATLANTA

STRETCH

turning business around

Headquarter: Atlanta Stretch Italy Spa

Subsidiaries: Atlanta Stretch Australia - Atlanta Stretch China - Atlanta Stretch Deutschland - Atlanta Stretch France - Atlanta Stretch Iberica - Atlanta Stretch India - Atlanta Stretch Mexico - Atlanta Stretch Russia - Atlanta Stretch SEA - Atlanta Stretch Sweden - Atlanta Stretch Turkey - Atlanta Stretch UK



View all optional tools here

www.atlantastretch.com

Find all our dealers

