

ATLANTA

STRETCH

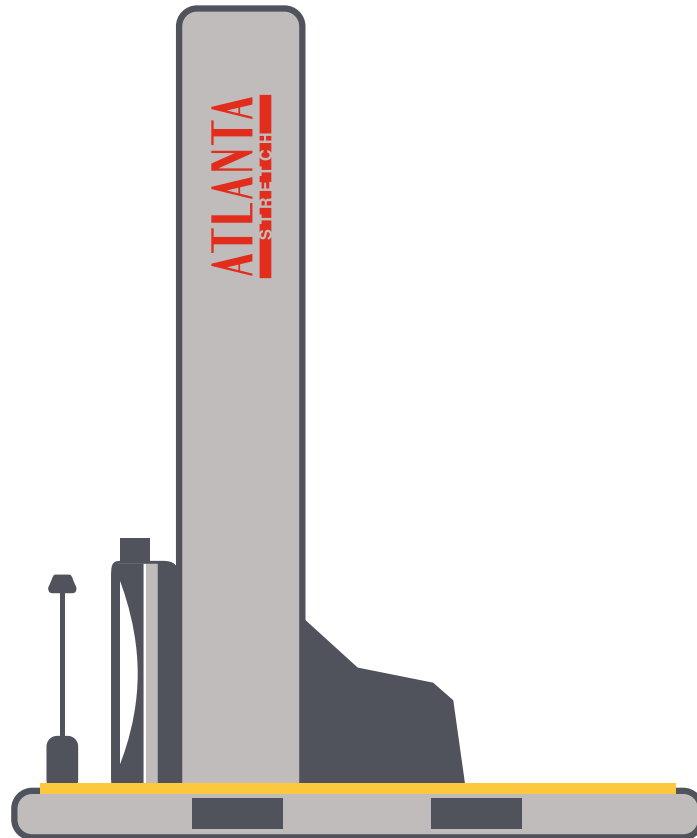

SYNTHESI

SEMI AUTOMATIC PALLET WRAPPER
MAINTENANCE FREE
EASY INSTALLATION

**Semi automatic turntable
for wrapping pallets with stretch film**

SYNTHESI

Input: 230 Volt
1 PHASE



SYNTHESI TP VERSION

Input: 230 Volt
1 PHASE

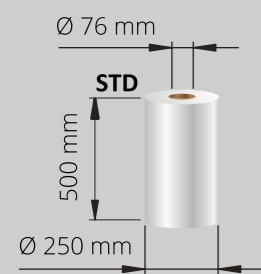
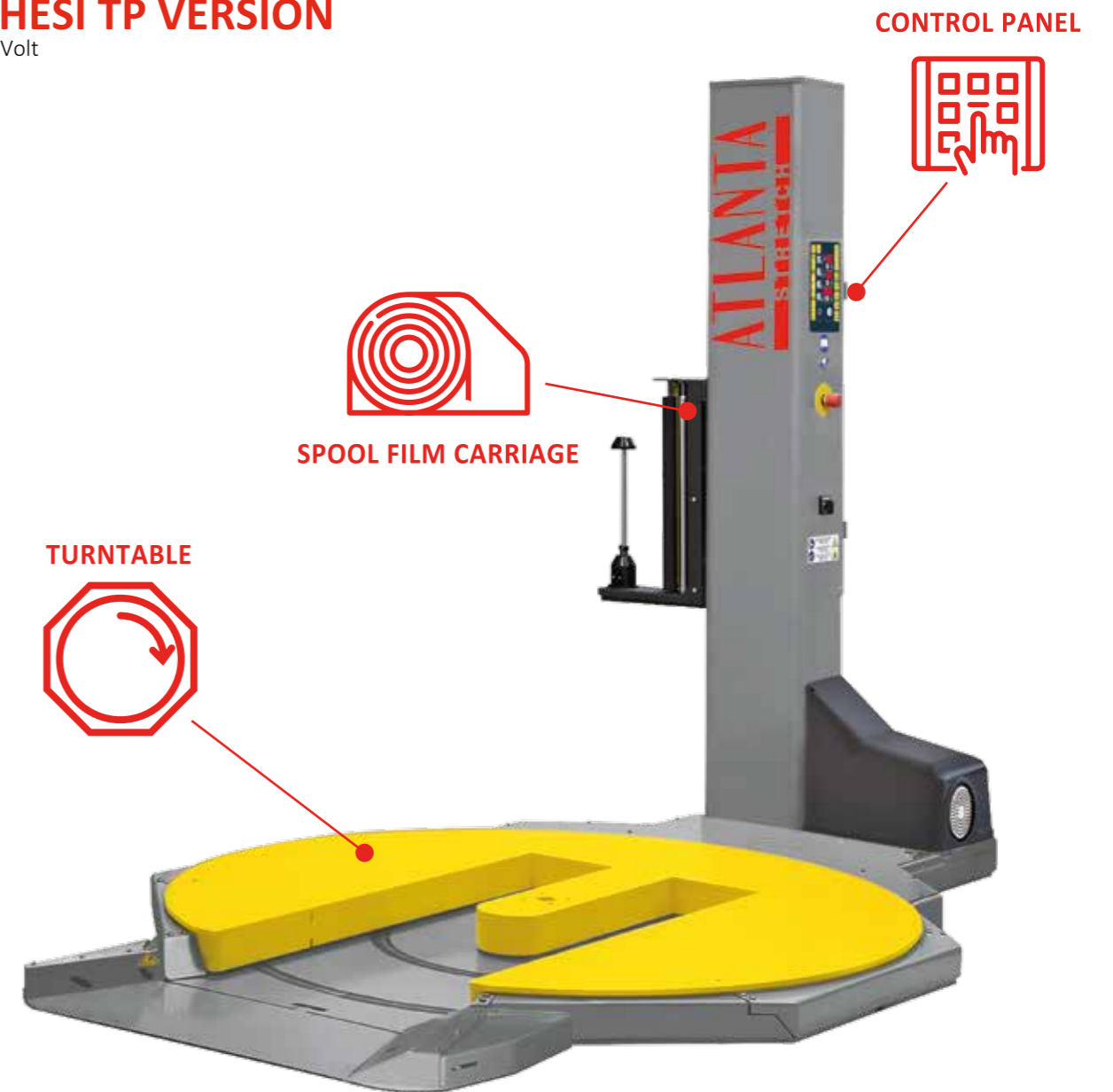

PALLET DIMENSIONS

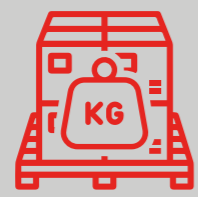

Max: 2000 Kg STD
Max: 3000 Kg OPT

- H = 2200 STD
- H = 2400 OPT
- H = 2500 OPT
- H = 3200 OPT
- H = 3500 OPT
- H = 3900 OPT

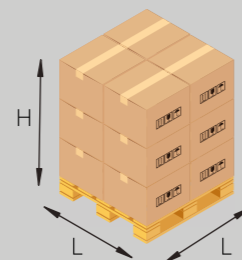

- L=800x1200 mm $\text{Ø } 1500 \text{ max STD}$
- L=1000x1200 mm $\text{Ø } 1650 \text{ max OPT}$
- L=1200x1200 mm $\text{Ø } 1800 \text{ max OPT}$
- L=1500x1500 mm $\text{Ø } 2200 \text{ max OPT}$
- L=1650x1650 mm $\text{Ø } 2400 \text{ max OPT}$
- L=1830x1830 mm $\text{Ø } 2600 \text{ max OPT}$

APPLICATIONS





ATLANTA STRETCH SELLING POINTS

ERGONOMIC SOLUTION FOR THE USER

- IT** L'attenzione alla sicurezza e al massimo comfort del lavoratore contribuiscono a migliorare la qualità del lavoro, diminuendo lo stress a favore della soddisfazione generale dell'utente
- EN** For the highest security and safety of the user and to achieve a better working environment, and higher satisfaction of the user.
- FR** Pour la plus grande sécurité et sûreté de l'utilisateur et pour obtenir un meilleur environnement de travail et une plus grande satisfaction de l'utilisateur.
- DE** Für höchste Sicherheit des Nutzers, sowie zur Erreichung eines besseren Arbeitsumfelds und Zufriedenheit
- ES** Para la mayor seguridad y protección del usuario y para lograr un mejor ambiente de trabajo, y una mayor satisfacción del usuario.



COMMERCIAL COMPONENTS AND INVERTERS AVAILABLE ON THE FREE MARKET

- IT** La facilità con cui i nostri componenti sono reperibili sul mercato contribuisce ad abbatterne il prezzo con notevole risparmio per l'utente.
- EN** The use of commercial components in all our products means higher reliability and lower costs but also flexibility in terms of materials supply.
- FR** La façon dont nous nous approvisionnons et spécifions des niveaux élevés pour les composants de nos produits, signifie que vous bénéficierez de niveaux de fiabilité élevés et constants
- DE** Der Einsatz handelsüblicher Komponenten in all unseren Produkten bedeutet höhere Zuverlässigkeit und geringere Kosten, aber auch Flexibilität bei der Materialversorgung.
- ES** El uso de componentes comerciales en todos nuestros productos significa mayor confiabilidad y menores costos, pero también flexibilidad en términos de suministro de materiales.



POSSIBILITY TO ADJUST TENSION ON LOAD AND PRE STRETCH IN EVERY STEP OF THE WRAPPING CYCLE

- IT** I nostri carrelli offrono la possibilità di regolare in maniera mirata la tensione del film e il pre-stirò in ogni fase dell'avvolgimento.
- EN** Our carriages are standard equipped with the possibility to adjust film tension and pre-stretch during every phase of the wrapping process.
- FR** Nos chariots sont tous équipés en mode standard avec la possibilité de régler la tension du film et de le pré-étirer à chaque étape du processus d'emballage.
- DE** Unsere Folienschlitten sind so konzipiert, dass sowohl die Anlegespannung als auch die Folienvordehnung in jeder Phase des Wickelzyklus regulierbar sind.
- ES** Nuestros carros están equipados de serie con la posibilidad de ajustar la tensión de la película y preestirar durante cada fase del proceso de envoltura.

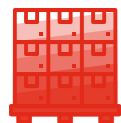

OPERATING PANEL



DISPLAY 11" easy to use touch screen

3 PROGRAMS

- IT** Pannello di controllo multifunzionale programmabile
- EN** Multifunction programmable control panel
- FR** Panneau de controle multifonction programmable
- DE** Multifunktion programmierbare Systemsteuerung
- ES** Panel de control programable multifuncion



MEANS OF LOADING

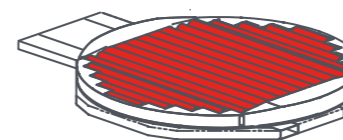
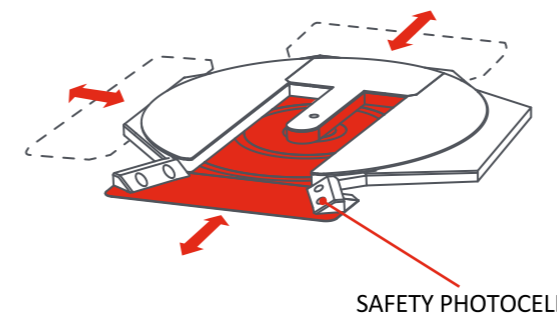
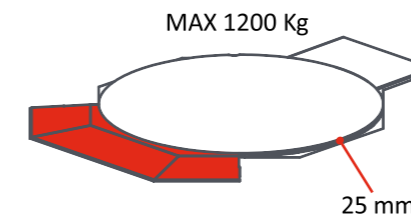
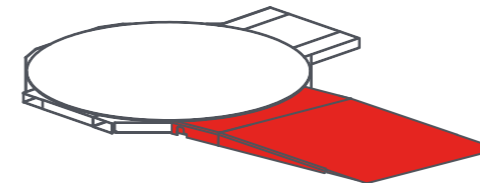
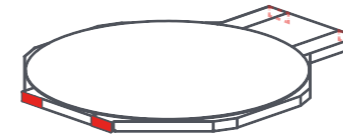

FORK SLOTS ON BOTH SIDES FOR EASY TRANSPORT



- IT** Trasporto facile
- EN** Easy transport
- FR** Transport facile
- DE** Einfachen transport
- ES** Facil transporte

LOADING RAMP



- IT** Rampa di carico
- EN** Loading ramp
- FR** Rampe
- DE** Ladungsrampe
- ES** Rampa de carga

LOW PROFILE BASEMENT



- IT** Basamento basso per transpallet manuale. Altezza da terra di soli 25 mm! Solo per tavola da Ø 1650
- EN** Low profile 25 mm high turntable, designed to ease manual loading! Only available for Ø 1650 table
- FR** Châssis extra fin pour transpalette manuel. Hauteur de seulement 25 mm!
- DE** Flaches Drehtellergestell für Handhubwagen, Höhe nur 25 mm!
- ES** Base con perfil bajo especial para transpaletas. Altura solo 25 mm!

TP BASEMENT



- IT** Versione transpallet con 3 possibili vie di carico. Direzione di ingresso tp modificabile anche dopo consegna.
- EN** Transpallet version with 3 in-feeds. Infeed direction changeable lifetime.
- FR** Ausführung Transpallet mit 3 adenmöglichkeiten.
- DE** Version transpalette 3 voies.
- ES** Version transpallet 3 posiciones de carga.

Pallet dimension
 Ø 1650 Max 1000x1200 mm
 Ø 1800 Max 1200x1200 mm
 Max weight 1200 kg

IDLE ROLLERS ON THE TURNTABLE



- IT** Rulliera non motorizzata
- EN** Non-motorized roller conveyor
- FR** Non motorisés à rouleaux
- DE** Nicht-Motorisierte Rollenbahn
- ES** Rodillos no motorizados

WRAPPING PROGRAMS

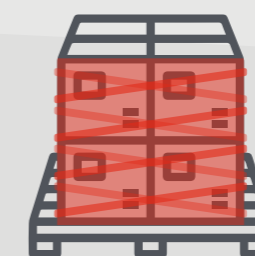

 **SPOOL FILM CARRIAGE**



EASY FILM CHANGE

- IT** Cambio film semplificato, altezza di arresto del carrello porta bobina automatico.
- EN** Easy reel change, adjustable service height.
- FR** Changement de bobine facile, hauteur de service réglable.
- DE** Einfacher Folienwechsel in ergonomischer Arbeitshöhe.
- ES** Cambio fácil de bobina, altura de embalaje ajustable.

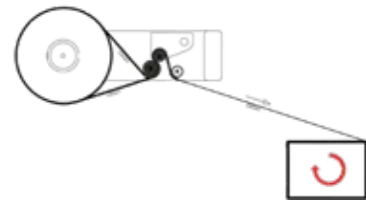

FM

- IT** Freno meccanico regolabile manualmente.
- EN** Mechanical brake manually adjustable.
- FR** Frein mécanique ajustable manuellement.
- DE** Mechanische Bremse auf Umlenkwalze.
- ES** Fricción mecánica regulable anualmente.

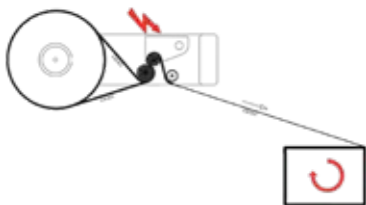

FE

- IT** Frizione elettromagnetica regolabile da pannello comandi.
- EN** Electromagnetic friction adjustable from control panel.
- FR** Frein électromagnétique réglable depuis le panneau de commande.
- DE** Elektromagnetische Bremse auf Umlenkwalze vom Bedienpult instellbar.
- ES** Fricción electromagnética regulable desde el panel de comandos.

 **OPTIONALS**

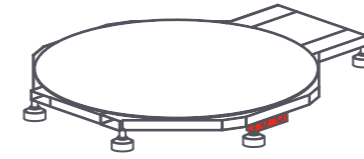

INTEGRATED WEIGHTING SYSTEM (ALSO FOR TP TURNTABLE)

- IT** Sistema elettronico per l'indicazione del peso del estensibile utilizzato.
- EN** Integrated calculation system, to indicate the weight of the used stretchfilm.
- FR** Système de calcul intégré pour indiquer le poids de film utilisé.
- DE** Integriertes Berechnungssystem, um das Gewicht des verwendeten Stretchfilms anzuzeigen.
- ES** Sistema integrado de cálculo, que indica el peso del plástico de preestiro utilizado.

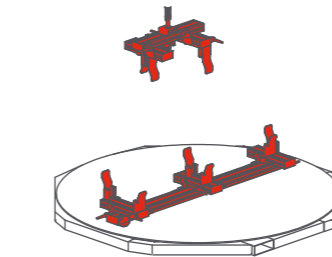

DOORS AND WINDOWS WRAPPING SYSTEM

- IT** Sistema di imballo per porte e finestre.
- EN** Doors and windows wrapping system.
- FR** Système d'emballage pour portes et fenêtres.
- DE** Wickelsysteme für Fenster und Türen.
- ES** Sistema de embalaje para puertas y ventanas.

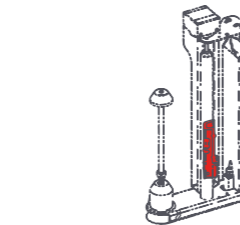

AUTOMATIC FILM CUT FOR FE CARRIAGE

- IT** Sistema di taglio automatico del film a fine ciclo.
- EN** Automatic Film cutting Device at cycle end.
- FR** Coupe automatique du film.
- DE** Automatische Folienschneidvorrichtung am Zyklusende.
- ES** Sistema automatico de corte film con fin de ciclo.

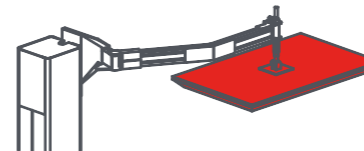

TOP PRESSURE UNIT

- IT** Pressore tenuta pallet
- EN** Pallet holder presser
- FR** Plateau stabilisateur de charge
- DE** Palettendruckhalter
- ES** Presor retención palet

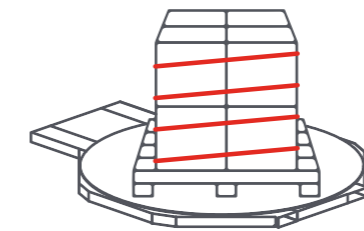

ROPING SYSTEM

- IT** Sistema di cordatura film: Permette di ridurre l'altezza del film formando un cordone che assicura una più efficiente stabilizzazione del carico.
- EN** Roping System: Reducing the film width to form a rope to ensure more effective load stabilisation.
- FR** Système permettant de réduire la laize du film en formant un cordon qui assure une meilleure stabilisation de la charge.
- DE** Schnurrvorrichtung: Reduzierung der Folienbreite zur Schnur um eine bessere Stabilisierung der Ladung zu gewährleisten.
- ES** Sistema de Cordón. Permite reducir la altura del film formando un cordón que asegura con más eficacia la estabilidad de la carga.



LOW TEMPERATURE MACHINE

- 5 coldstore version • -30 freezer version • inox version

SEMI AUTOMATIC RANGE

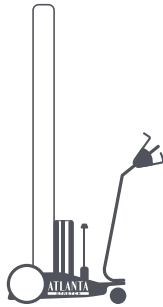

MARATHON

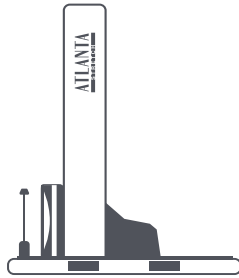

EVA

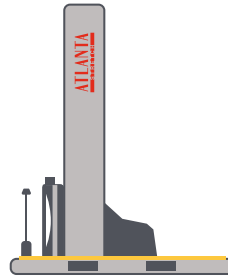

SYNTHESI

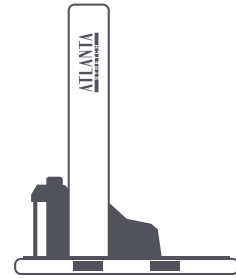

SYNTHEX

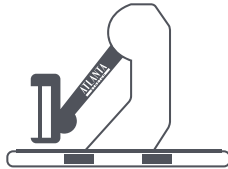

MYTHO ARM

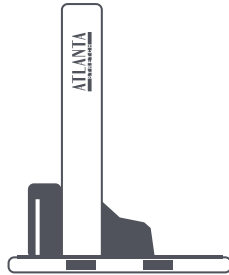

MYTHO MAST



SFERA

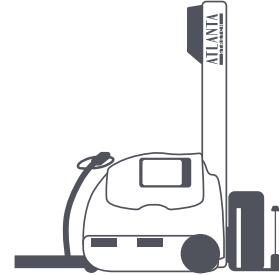

SFERA MAST

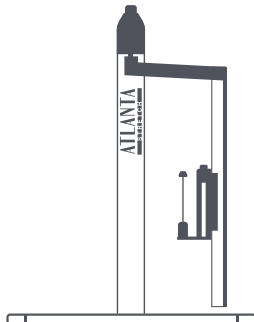

LYBRA EASY

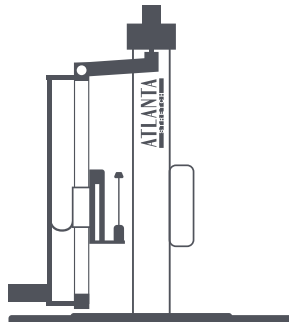

LYBRA

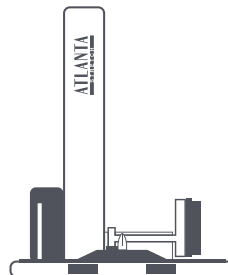

MYTHO AUTO

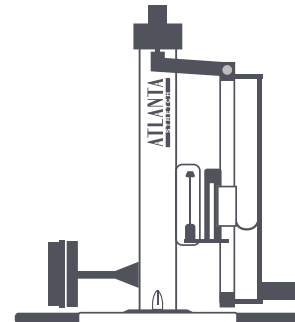

LYBRA AUTO

Atlanta Stretch Authorized dealer

ATLANTA
STRETCH
stretch wrapping machines specialist

Headquarter: Atlanta Stretch Italy Spa

Subsidiaries: Atlanta Stretch Australia - Atlanta Stretch China - Atlanta Stretch Deutschland - Atlanta Stretch France - Atlanta Stretch Iberica - Atlanta Stretch India - Atlanta Stretch Mexico - Atlanta Stretch Russia - Atlanta Stretch SEA - Atlanta Stretch Turkey - Atlanta Stretch UK



View all
optional tools
here

www.atlantastretch.com



Find
all our
dealers